

Front view

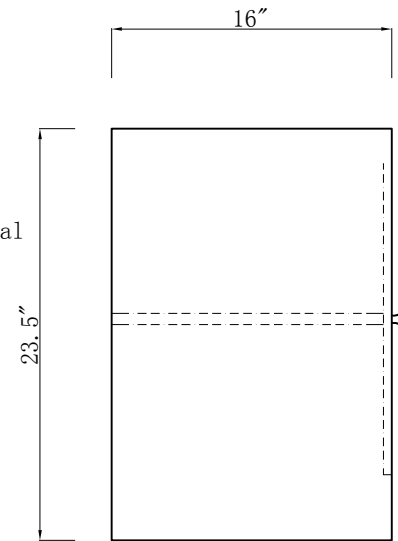

Side view

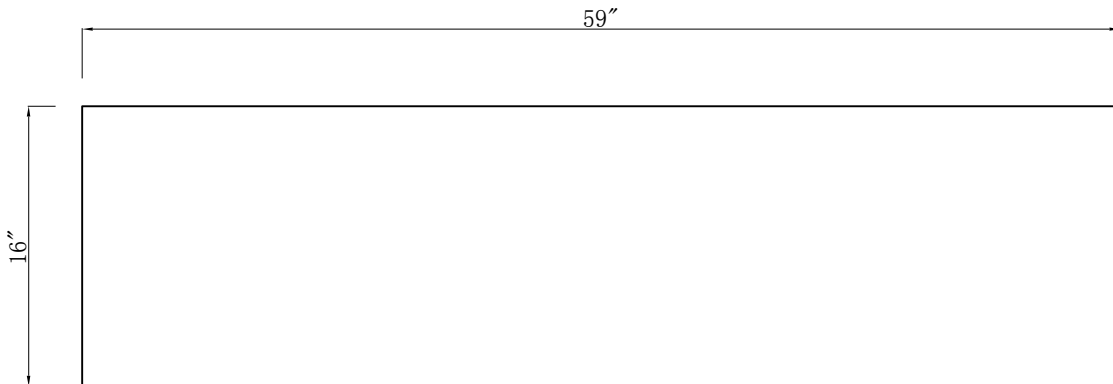

Top view

DWG. NO. :

MODEL NO. : MF9904

ALTERATIONS

1

2

3

4

FOR PROPOSAL ONLY ALL DIMENSIONS TO BE VERIFIED

SCALE:

DWG. BY:

CHECKED BY:

DATE: July 11th, 2018

PROJECT:

Qty:

Color:

DRAWING TITLE:

FINISH:



## FP02

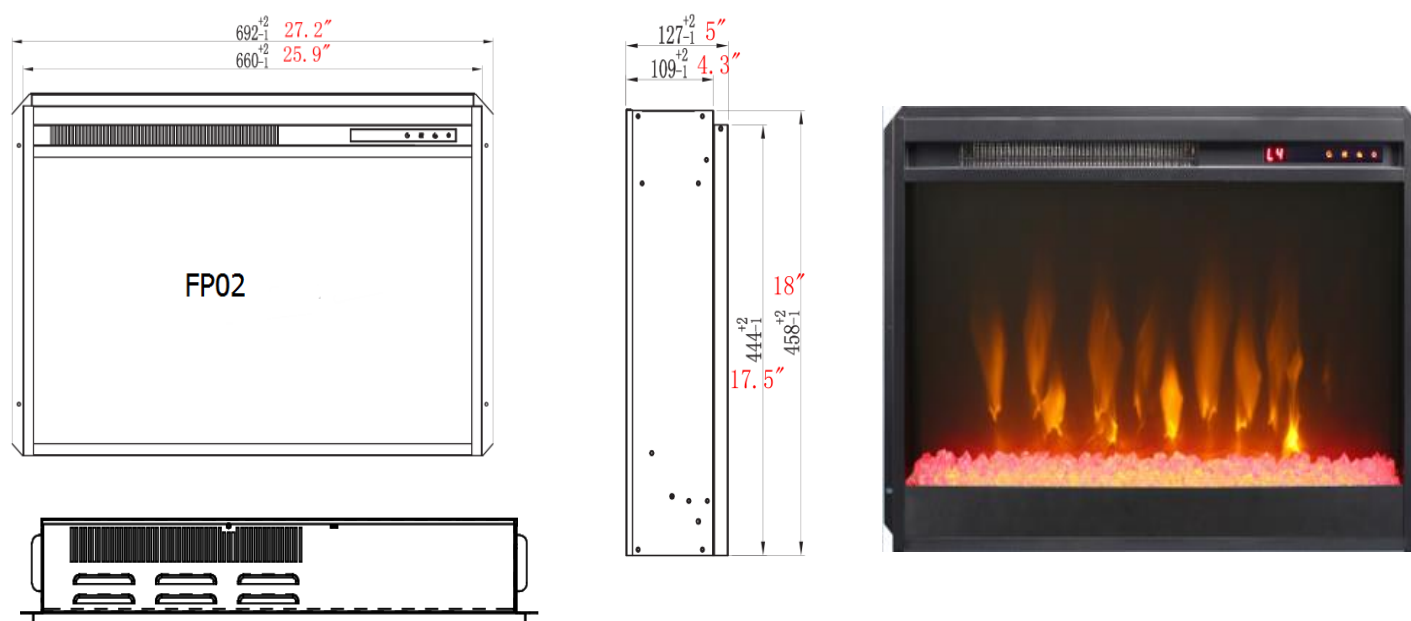

Model	FP02	adjustable thermostat	YES
Room Use	YES	Has a timer	YES
firebox length (in)	27	firebox removable	NO
firebox width (in)	5	blower/fan included	YES
firebox height (in)	18	firebox included	YES
firebox exterior finish	Black	fireplace remote included	YES
flame finishes	Yellow & Red	require batteries	NO
crystal finishes	Transparent color	flame operational without heat	YES
power cord length (in)	70.8	thermal overload protection	YES
power cord amperages (amps)	11.7A	Screen included	YES
Orientation	Insert	firebox glass is tempered	YES
Overall Material	Matal + Glass + Plastic	assembly required	NO
firebox filler type	Insert	safety stop	NO
Combustion air vent type	Coil Resistance Heating	commercial or residential certificatio	CSA,UL,CE
Fuet type	electric	indoor use	Indoor
electric flame type	LED	warranty	1year
Maximum BTU output	4777	Product Weight	22lbs
Space heating capacity ( sqft)	400	Shipment type	small parcel
Plug in	YES	Box 1 Length (in)	28
Voltage (volts)	120V	Box 1 Width (in)	6
wattage (watts)	1400W	Box 1 Height(in)	19
adjustable flame	YES	total carton weight	24.2lbs
flickering flame effect	YES	Carton Quantity:	1PCS
infrared technology	NO		

# OPERATING MANUAL

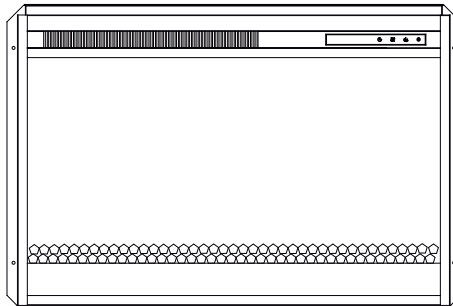

Thank you for choosing our product(s).

Our company is actively involved in every step of the production.

Our product(s) are designed to be utilized for every application that graces your home or business.

We pride ourselves in providing the most prompt and courtesy service to all of the valued customers.

Please find the enclosed detailed instructions and read carefully for proper installation. If you have any questions, our professional customer service team is committed to assisting you, please call our toll free HOTLINE AT:

# IMPORTANT INSTRUCTIONS

When using electrical appliances, basic precautions should always be followed to reduce the risk of fire, electrical shock, and/or injury including the following:

1. Read all instructions before using this heater.
2. This heater is hot when in use. To avoid burns, do not let bare skin touch hot surfaces. If provided, use handles when moving this heater.  
DANGER: High temperature may be generated under certain abnormal conditions. Do not partially or fully cover or obstruct the front of the heater.  
WARNING: In order to avoid overheating, do not cover the heater. It cannot be used in a closet.
3. CAUTION: The appliance should not be used by children or persons with reduced physical, sensory or mental capabilities.
4. Children should be advised not to play with the appliance.
5. Always unplug this appliance when not in use.
6. Do not operate any heater with a damaged cord or plug or after the appliance malfunctions, or if it has been dropped or damaged in any manner.
7. If the supply cord is damaged, it must be replaced by the manufacturer, it's service agent or similarly qualified persons in order to avoid a hazard.
8. Any repairs to this fireplace should be carried out by a qualified service person.
9. Under no circumstances should this fireplace be modified. Parts having to be removed for servicing must be replaced prior to operating this fireplace again.
10. Do not use outdoors.
11. This heater is not intended for use in bathrooms, laundry areas and similar indoor locations. Never locate this appliance where it may fall into a bathtub or other water container.
12. Do not run cord under carpeting. Do not cover cord with throw rugs, runners or the like. Arrange cord away from traffic areas and where it will not be tripped over.
13. To disconnect this appliance, turn controls to the off position, then remove plug from outlet.
14. Connect to properly grounded outlet only.
15. This appliance, when installed, must be electrically grounded in accordance with local codes or, in the absence of local codes, with the current CSA C22.1 Canadian Electrical Code or for USA installations, follow local codes and the National Electrical Code, ANSI/NFPA NO.70.
16. There is a protective thermostat limiter inside the heater. When the inner temperature over heat, the thermostat limiter will shut off the power supply to avoid the risk of fire damage to the appliance.
17. The heaters must not be located immediately below a socket-outlet.
18. Do not insert or allow foreign objects to enter any ventilation or exhaust opening as this may cause an electric shock or fire, or damage the appliance.
19. To prevent a possible fire, do not block air intakes or exhaust in any manner. Do not use on soft surfaces, like bed, where opening may become blocked.
20. This appliance has hot and arcing or sparking parts inside. Do not use where gasoline, paint, or flammable liquids are used or stored. This fireplace should not be used as a drying rack for clothing. Christmas stockings or decorations should not be hung in area of it.
21. Use this appliance only as described in the manual. Any other use not recommended by the manufacturer may cause fire, electric shock or injury to persons.
22. Always plug heaters directly into a wall outlet/receptacle. Never use with an extension cord or relocatable power tap (outlet/power strip).

## SAVE THESE INSTRUCTIONS

# INSTALLATION INSTRUCTION

Position your completed mantel close to its final location. Make sure you can access the back of the mantel as your electric fireplace appliance will be installed from back.

Using a Phillips head screwdriver, remove the screws and the metal mounting center opening. Next unpack the electric fireplace appliance carefully. Position the appliance behind the fireplace with front facing the wood mantel. With the help of an adult assistant, lift the appliance and gently slide it into the opening in the mantel. Make sure the appliance is centered left and right in the opening. Be careful when placing appliance and adjusting, bottom of appliance could scratch the finish of the base/hearth of your fireplace. Re-attach the mounting brackets with the Phillips head screwdriver, and supplied screws.

**DO NOT OVER TIGHTEN.** With the help of an assistant, carefully lift completed unit and place it with the front facing out in the final location you have chosen for your fireplace. Make sure to secure the electrical cord before lifting or moving completed fireplace. When choosing a final location, make sure you will have clear access to grounded electrical outlet.

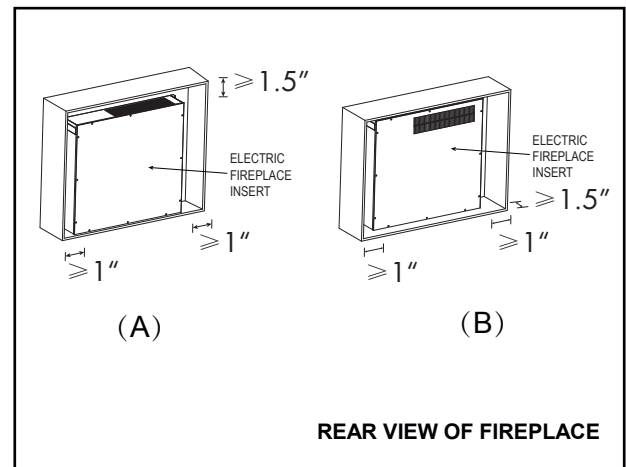

## INSTALLING THE EMBER BEDS

If you purchased the electric fireplace with crystals or pebbles, you should installing the ember beds before you install the fireplace into the mantel.

You will need one phillips head screwdriver to complete the following instructions:

1. Remove the 4 screws on the back left and right sides of the firebox that hold the glass front in place.
2. Carefully remove the glass front.
3. Arrange the ember beds along the inset window ledge at the front of the electric fireplace.
4. Replace the glass front.
5. Line up the holes on the front with the holes on the firebox and insert and tighten 4 screws to hold the glass front in place.

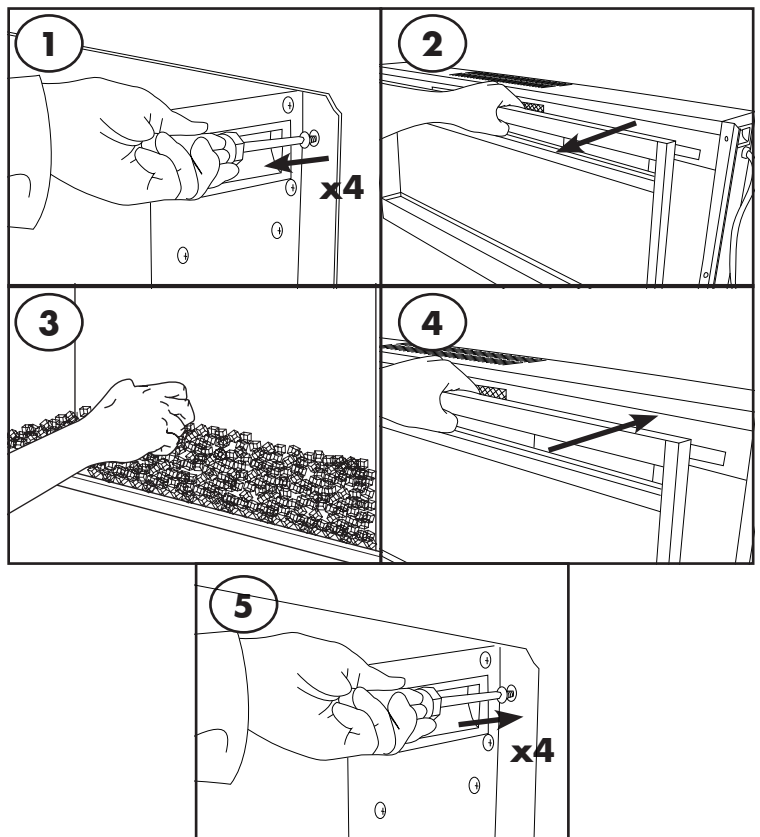

## GROUNDING INSTRUCTIONS:

This heater is for use on 120 volts. The cord has a plug as shown at (A) in figure 2. An adapter as shown at (C) is available for connecting three-blade grounding-type plugs to two-slot receptacles. The green grounding lug extending from the adapter must be connected to a permanent ground such as a properly grounded outlet box. The adapter should not be used if a three-slot grounded receptacle is available.

**NOTE: Adapters are NOT for use in Canada**

Figure 2

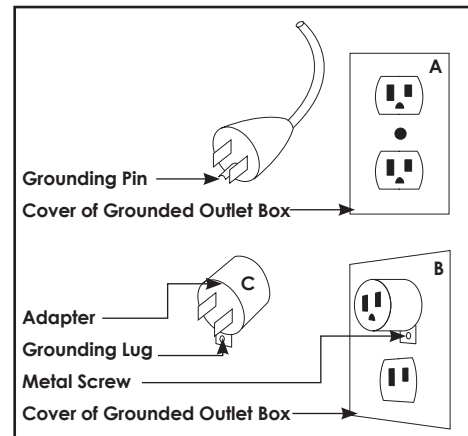

## ELECTRICAL SPECIFICATIONS

Voltage: 120VAC 60Hz

Watts: 1400 Watts



### **COLD CLIMATE INSTALLATION RECOMMENDATION:**

When installing this unit against a Non-insulated exterior wall or chase, it is mandatory that outer walls be insulated to conform to applicable insulation codes.

### **ELECTRICAL CONNECTION**

The unit comes standard with 6 feet (1.8M) three wire cord, exiting from the rear of the fireplace. Plan the installation to avoid the use of an extension cord.

### **CLEANING TRIM**

Clean the metal trim using a soft cloth, slightly dampened with citrus oil based product and buff with a clean soft cloth.

DO NOT use brass polish or household cleaners as these products will damage the metal trim. Citrus oil based products can be obtained at supermarkets or hardware stores.

### **MAINTENANCE**

The motors used on the fan and the flame generator assembly are pre-lubricated for extended bearing life and require no further lubrication. However, periodic cleaning/vacuuuming of the fan/ heater unit is recommended. Make sure the unit is turn OFF and unplugged whenever you are cleaning the heater of fireplace.

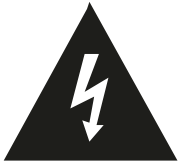

**WARNING :** Make sure the power is turned off before proceeding. Any electrical repairs or rewiring of this unit should be carried out by a licensed electrician in accordance with national and local codes. If repairing or replacing any electrical component or wiring, the original wire routing, color coding and securing locations must be followed.



**WARNING :** Electric outlet wiring must comply with local building codes and other applicable regulations to reduce risk of fire, electric shock and injury to persons.



**WARNING :** Do not use this fireplace if any part of it has been under water. Immediately call a qualified service technician to inspect the fireplace and replace any part of the electrical system.



**WARNING :** Disconnect power before attempting any maintenance or cleaning to reduce the risk of fire, electrical shock or personal injury.



**WARNING :** During any service of this appliance, the power to the unit must be turned off, Always remember to remove the electrical plug from the wall outlet.

# OPERATING INSTRUCTION

On the top-right of the electric firebox is the touchscreen control panel. This panel contains the buttons to properly operate the electric fireplace. The buttons on the remote control function in the same way. The remote control has an effective range of up to 6 m.

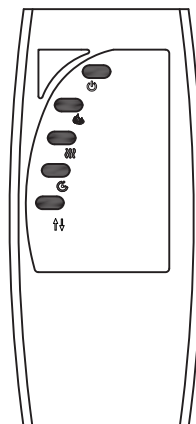
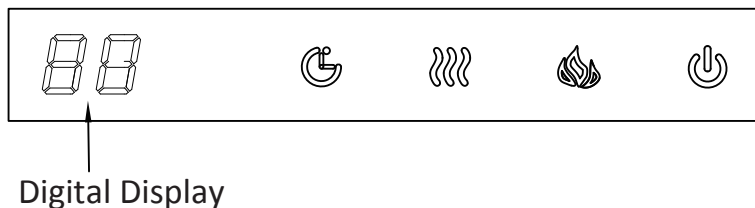

NOTE: The remote control is intended only for the functional operation of the product, It can not lock/unlock the heating function !

## POWER

The POWER button turns the appliance on or off. It has a memory function; the button turns off all functions at once but retains the settings in the memory. By pressing the button again, the unit will turn on at the same settings. If the TIMER has set & time has expired all functions will stop. Press the POWER button start the appliance.

## FLAME

The FLAME control switch manages the flame brightness. There are 4 brightness levels and an off position. Each time the FLAME button is pressed, the intensity of the flame decrease. When adjusting the FLAME button, a number indicating the brightness of flame will be visible on the digital display. After turning on digital display, if nothing happens within 10 seconds, digital display will turn off.

## HEATER

The HEATER button turns the heater on and off. When in ON position, press and hold the HEATER button 5 seconds and enter temperature adjustment mode (Note: This can't be set with the remote control). In the adjustment mode, the digital display will flash at 0.5 second intervals. There are 11 temperature settings: 72 °F -74 °F -76 °F -78 °F -80 °F -82 °F -ON-64 °F ---72 °F (22 °C -23 °C -24 °C -25 °C -26 °C -27 °C -ON-18 °C ---22 °C ) After the temperature is selected the digital display will flash 5 times and exit from setting status. After turning on the digital temperature display, if nothing happen within 10 seconds, the digital display will expire.

Temperature unit convert function: With the heater is ON the position, press and hold the power icon for 5 seconds, current temperature unit display will flash 3 times and convert to another temperature unit **(Note: This can't be set with the remote control)**.

Lock & unlock heater function: press and hold the heater icon for 10 seconds, the ember bed will flash 6 times, indicating that the heater function is locked. To unlock the heater function, just repress and hold the heater icon for 10 seconds again, then the ember bed will also flash 6 times indicating the heater function is unlocked and to recover the original states which you have set **(Note: This can't be set with the remote control)**.



## TIMER

The TIMER has adjustable setting at range from 30 minutes to 6 hours and OFF. As shown the following: 30 minutes-1h-2h-3h-4h-5h-6h-OFF. If the digital display turns on and nothing happens within 10 seconds, the digital display will auto shut off. Once you have set the timer, and the timer is up, close all the functions and enter standby mode. In this mode, you should touch the power icon to restart the appliance.

## INCREASE/DECREASE BUTTON

With the heater on, press the Increase/Decrease button to change the desired temperature. There are 11 temperature settings: 72 °F -74 °F -76 °F -78 °F -80 °F -82 °F -ON-64 °F ---72 °F (22 °C -23 °C -24 °C -25 °C -26 °C -27 °C -ON-18 °C ---22 °C).

## BATTERIES REPLACEMENT

### NOTE:

- Do not mix old and new batteries.
- Do not mix alkaine, standard (carbon zinc), or rechargeable (nicad, nimh, etc.) batteries.
- Do not ingest batteries.

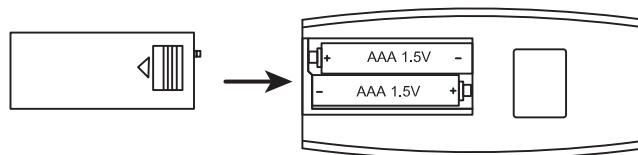

### CAUTION:

- Always purchase the correct size and grade of battery most suitable for the intended use.
- Replace all batteries of a set at the same time.
- Clean the battery contacts and also those of the device prior to battery installation.
- Ensure the batteries are installed correctly with regard to polarity (+ and -).
- Remove batteries from equipment which is not to be used for an extended period of time.
- Remove used batteries promptly

## TROUBLESHOOTING

Fault code	Fault Cause	Solution
E1	The heater overheating	Call after-sales service.
E2	NTC is defective.	Call after-sales service.
E3	The heater not working.	If the vents are dirty or clogged. Unplug the power, clean the dust and debris of the vent area. Wait for 5 minutes, plug in and turn on the heater. If the heater still don't work, please call after-sales service.

# 1 YEAR LIMITED WARRANTY

## Electrical Fireplace Basic Warranty

Our electrical fireplace is free from manufacturing and material defects for a period of one year from date of purchase, subject to the following conditions and limitations.

1. This electric fireplace must be installed and operated at all times in accordance with the installation and operating instructions furnished with the product, Any unauthorized repair, alteration, willful abuse, accident, or misuse of the product shall nullify this warranty.
2. This warranty is non-transferable, and is made to the original owner, provided that the purchase was made through an authorized supplier of the company.
3. The warranty is limited to the repair or replacement of parts found to be defective in material or workmanship, provided that such part(s) have been subjected to normal conditions of use and service, after said defect is confirmed by the Company's inspection.
4. The Company may, at its discretion, fully discharge all obligation with respect to this warranty by refunding the wholesale price of the defective part(s).
5. Any installation, labor, construction, transportation, or other related costs/expenses arising from defective part(s), repair, replacement, or otherwise of same, will not be covered by this warranty, nor shall the Company assume responsibility for same.
6. The owner/user assumes all other risks, if any, including the risk of any direct, indirect or consequential loss or damage arising out of the use, or inability to use the product, except as provided by law.
7. All other warranties-expressed or implied-with respect to the product, its components and accessories, or any obligation/liabilities on the part of the Company are hereby expressly included.
8. The Company neither assumes, nor authorizes any third party to assume, on its behalf, any other liabilities with respect to the sale of our product.
9. The warranties as outlined within this document do not apply to 3rd party accessories used in conjunction with the installation of this product.

This warranty is void if :

- a. The fireplace is subjected to prolonged periods of dampness or condensation.
- b. Any unauthorized alteration, willful abuse, accident, or misuse of the product.
- c. You do not have the original receipt of purchase.

|